

A-5-1.4 LW Series

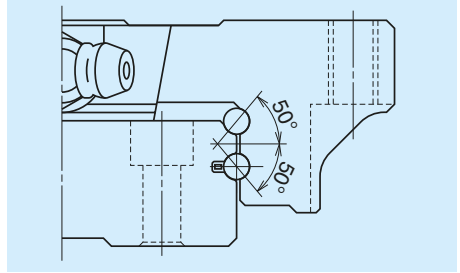
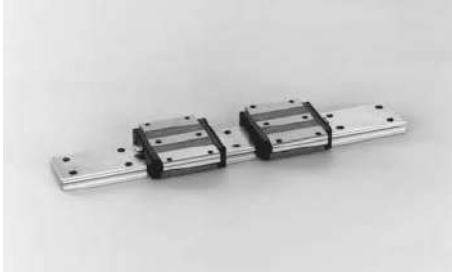

Fig. 1 Balls in contact

1. Features

(1) Ideal for use of single rail

Thanks to the wide rail, rigidity and load carrying capacity are high against moment load from rolling direction. This makes the LW Series ideal for a single rail, compact linear guideway system.

(2) High load carrying capacity to vertical direction

The contact angle is set at 50 degrees, increasing load carrying capacity as well as rigidity in vertical direction.

(3) High resistance against impact load

Same as the NH and NS series, the offset Gothic arch grooves support a large load, such as an impact, by four rows.

(4) High accuracy

Fixing master rollers to ball grooves is easy thanks to the Gothic arch groove. This makes easy and accurate measuring of ball grooves.

(5) Easy to handle, and designed with safety in mind.

Balls are retained in the retainer and do not fall out when a ball slide is withdrawn from the rail.

(6) Fast delivery

Lineup of random-matching rails and ball slides supports and facilitates fast delivery.

2. Ball slide shape

Ball slide Model	Shape / installation method	Type
EL		

3. Accuracy and preload

(1) Running parallelism of ball slide

Table 1

Unit: μm

Rail length (mm)		Preloaded assembly (not random matching)			Random-matching type
		High precision P5	Precision grade P6	Normal grade PN	Normal grade PC
over	or less				
-	50	2	4.5	6	6
50	- 80	3	5	6	6
80	- 125	3.5	5.5	6.5	6.5
125	- 200	4	6	7	7
200	- 250	5	7	8	8
250	- 315	5	8	9	9
315	- 400	6	9	11	11
400	- 500	6	10	12	12
500	- 630	7	12	14	14
630	- 800	8	14	16	16
800	- 1 000	9	16	18	18
1 000	- 1 250	10	17	20	20
1 250	- 1 600	11	19	23	23
1 600	- 2 000	13	21	26	26
2 000	- 2 500	15	22	29	29
2 500	- 3 150	17	25	32	32
3 150	- 4 000	23	30	34	34

(2) Accuracy standard

The preloaded assembly has three accuracy grades; High precision P5, Precision P6, and Normal PN grades, while the random-matching type has Normal PC grade only.

• Tolerance of preloaded assembly type

Table 2

Unit: μm

Characteristics	Accuracy grade	High precision P5	Precision grade P6	Normal grade PN
Mounting height H Variation of H (All ball slides on a set of rails)		± 20 7	± 40 15	± 80 25
Mounting width W_2 or W_3 Variation of W_2 or W_3 (All ball slides on reference rail)		± 25 10	± 50 20	± 100 30
Running parallelism of surface C to surface A Running parallelism of surface D to surface B		Shown in Table 1 and Fig. 2		

• Tolerance of random-matching type: Normal grade PC

Table 3

Unit: μm

Characteristics	Model No.	LW17, 21, 27, 35, 50
Mounting height H		± 20
Variation of mounting height H		15① 30②
Mounting width W_2 or W_3		± 30
Variation of mounting width W_2 or W_3		25
Running parallelism of surface C to surface A Running parallelism of surface D to surface B		See Table 1 and Fig. 2

Note: ① Variation on the same rail

② Variation on multiple rails

LW Series

(3) Combination of accuracy and preload

Table 4

		Accuracy grade			
		High precision	Precision grade	Normal grade	Normal grade
Without NSK K1 lubrication unit		P5	P6	PN	PC
With NSK K1 lubrication unit		K5	K6	KN	KC
With NSK K1 for food and medical equipment		F5	F6	FN	FC
Preload	Fine clearance Z0	○	○	○	—
	Slight preload Z1	○	○	○	—
	Medium preload Z3	○	○	—	—
	Random-matching type with fine clearance ZT	—	—	—	○
	Random-matching type with slight preload ZZ	—	—	—	○

Note: Z3 medium preload is only applicable to models of LW35 and LW50.

(4) Assembled accuracy

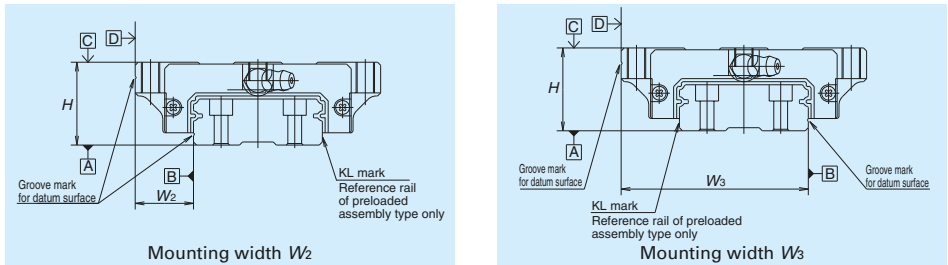

Fig. 2

(5) Preload and rigidity

We offer five levels of preload: Slight preload Z1, Medium preload Z3 and Fine clearance Z0, along with Random-matching type of Fine clearance ZT and Slight preload ZZ. Rigidities are for the median of the preload range.

• Preload and rigidity of preloaded assembly

Table 5

Model No.	Preload (N)		Rigidity (N/μm)			
			Vertical direction		Lateral direction	
	Slight preload Z1	Medium preload Z3	Slight preload Z1	Medium preload Z3	Slight preload Z1	Medium preload Z3
LW17 EL	0 – 245	—	156	—	112	—
LW21 EL	0 – 294	—	181	—	130	—
LW27 EL	0 – 390	—	226	—	167	—
LW35 EL	0 – 490	785	295	440	213	315
LW50 EL	0 – 590	1 470	345	600	246	425

Note: Clearance for Fine clearance Z0 is 0 to 3μm. Therefore, preload is zero.
However, Z0 of PN grade is 0 to 15μm.

• Clearance and preload of random-matching type

Table 6 Unit: μm

Model No.	Fine clearance	Slight preload
	ZT	ZZ
LW17	-3 - 15	-3.5 - 0
LW21	-3 - 15	-3.5 - 0
LW27	-4 - 15	-4 - 0
LW35	-5 - 15	-5 - 0
LW50	-5 - 15	-7 - 0

Note: Minus sign denotes elastic deformation of balls representing.

5. Installation

(1) Permissible values of mounting error

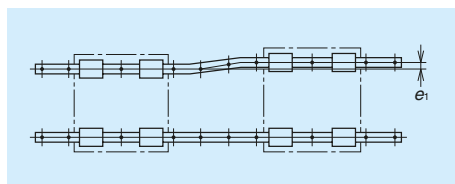

Fig. 3

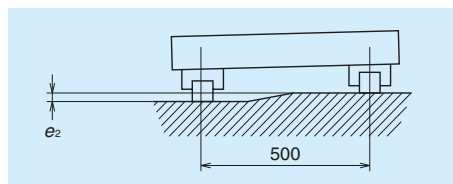

Fig. 4

4. Maximum rail length

• Table 7 shows the limitations of rail length (maximum length). However, the limitations vary by accuracy grade.

Table 7 Length limitations of rails

Series	Material	Size				
		17	21	27	35	50
LW	Special high carbon steel	1 000	1 600	2 000	2 000	2 000

Note: Rails can be butted if user requirement exceeds the rail length shown in the table. Please consult NSK.

Table 8

Unit: μm

Value	Preload	Model No.				
		LW17	LW21	LW27	LW35	LW50
Permissible values of parallelism in two rails e_1	Z0, ZT	20	20	25	38	50
	Z1, ZZ	9	9	13	23	34
Permissible values of parallelism (height) in two rails e_2	Z0, ZT	100 $\mu\text{m}/500\text{ mm}$				
	Z1, ZZ	45 $\mu\text{m}/500\text{ mm}$				

(2) Shoulder height of the mounting surface and corner radius

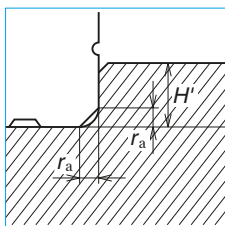

Fig. 5 Shoulder for the rail datum surface

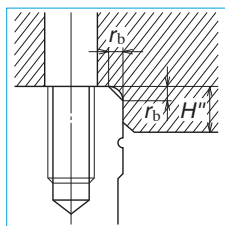

Fig. 6 Shoulder for the ball slide datum surface

Table 9

Unit: mm

Model No.	Corner radius (maximum)		Shoulder height	
	r_a	r_b	H'	H''
LW17	0.3	0.3	2.2	4
LW21	0.3	0.3	2.5	5
LW27	0.5	0.5	3.5	5
LW35	0.5	0.8	3.5	5
LW50	0.8	0.8	4	6

LW Series

6. Lubrication components

Refer to pages A38 and D13 for the lubrication of linear guides.

(1) Types of lubrication accessories

Fig. 7 and Table 10 show grease fittings and tube fittings.

We provide lubrication accessories with extended thread body length (L) for the addition of dust-proof accessories such as NSK K1 lubrication unit, double seal and protector.

We provide a suitable lubrication accessory for the special requirement on dust-proof accessories.

Consult NSK for a lubrication accessory with extended length of thread body for your convenience of replenishing lubricant.

Please ask NSK for stainless lubrication accessories.

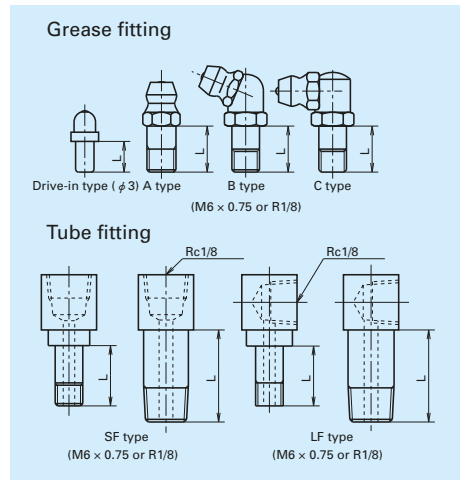

Fig. 7 Grease fitting and tube fitting

Table 10 Unit: mm

Model No.	Dust-proof specification	Dimension L		
		Grease fitting / Drive-in type	Tube fitting	
			SF type	LF type
LW17	Standard	5	-	-
	With NSK K1	10	-	-
	Double seal	*	-	-
	Protector	*	-	-
LW21	Standard	5	-	-
	With NSK K1	12	-	-
	Double seal	10	-	-
	Protector	10	-	-
LW27	Standard	5	5	5
	With NSK K1	12	12	12
	Double seal	10	9	9
	Protector	10	9	9
LW35	Standard	5	6	6
	With NSK K1	14	14	13
	Double seal	10	10	9
	Protector	10	10	9
LW50	Standard	8	13.5	17
	With NSK K1	18	18	19
	Double seal	14	16	17
	Protector	14	13.5	17

*) A connector is required for the grease fitting. Please contact NSK.

(2) Mounting position of lubrication accessories

The standard position of grease fittings is the end face of ball slide. We may mount them on a side of end cap for LW27, 35, and 50 as an option. (Fig. 8)

Please consult NSK for installation of grease or tube fittings to the ball slide body or side of end cap.

When using a piping unit with thread of $M6 \times 1$, you require a connector for a connection to a grease fitting mounting hole with $M6 \times 0.75$. The connector is available from NSK.

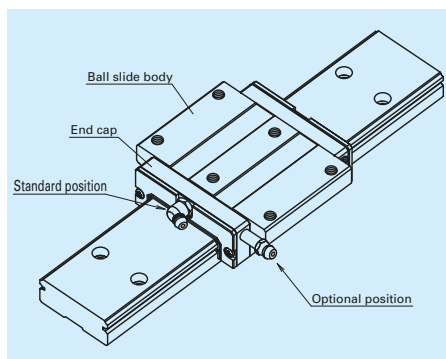

Fig. 8 Mounting position of lubrication accessories

LW Series

7. Dust-proof components

(1) Standard Specification

The LW Series can be readily used as they have a dust protection means for normal conditions. As the standard equipment, the series has an end seal on both ends and bottom seals at the bottom.

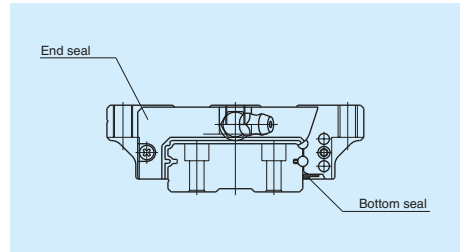

Fig. 9

Table 11 Seal friction per ball slide (maximum value) Unit: N

Series \ Size	17	21	27	35	50
LW	6	8	12	16	20

(2) NSK K1™ lubrication unit

Table 12 shows the dimension of linear guides equipped with the NSK K1 lubrication unit.

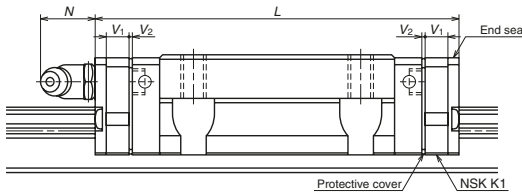

Table 12

Unit: mm

Model No.	Ball slide length	Ball slide model	Standard ball slide length	Ball slide length installed with two NSK K1 L	Per NSK K1 thickness V_1	Protective cover thickness V_2	Protruding area of the grease fitting N
LW17	Standard	EL	51.4	61.6	4.5	0.6	(5)
LW21	Standard	EL	58.8	71.4	5.5	0.8	(13)
LW27	Standard	EL	74	86.6	5.5	0.8	(13)
LW35	Standard	EL	108	123	6.5	1.0	(13)
LW50	Standard	EL	140.6	155.6	6.5	1.0	(14)

Note: 1) NSK K1 for food and medical equipments are available for the models of LW17 to LW35.

2) Ball slide length equipped with NSK K1 = (Standard ball slide length) + (Thickness of NSK K1, $V_1 \times$ Number of NSK K1) + (Thickness of the protective cover, $V_2 \times 2$)

(3) Double seal

Use a double seal set as showing in **Table 13**, when installing an extra seal to completed standard products. (**Fig. 10**)

When installing a grease fitting after the installation of double seals, a connector as showing **Fig. 10** is required.

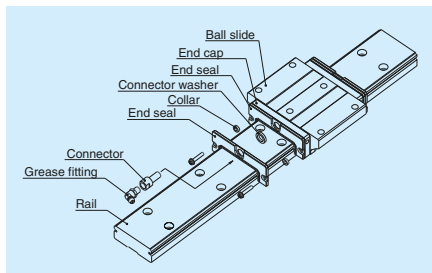

Fig. 10 Double seal

(4) Protector

Use a protector set as showing **Table 14**, when installing a protector to completed standard products. (**Fig.11**)

When installing a grease fitting after the installation of protectors, a connector as showing **Fig.11** is required.

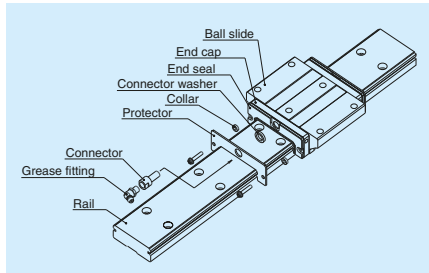

Fig. 11 Protector seal

Table 13 Double-seal set

Model No.	Reference No.		Increased thickness V_3 (mm)
	Without connector	With connector	
LW17	LW17WS-01	*	2.6
LW21	LW21WS-01	LW21WSC-01	2.8
LW27	LW27WS-01	LW27WSC-01	2.5
LW35	LW35WS-01	LW35WSC-01	3
LW50	LW50WS-01	LW50WSC-01	3.6

*) For installation of a connector to a drive-in type grease fitting, contact NSK.

Table 14 Protector set

Model No.	Reference No.		Increased thickness V_4 (mm)
	Without connector	With connector	
LW17	LW17PT-01	*	3.2
LW21	LW21PT-01	LW21PTC-01	3.2
LW27	LW27PT-01	LW27PTC-01	2.9
LW35	LW35PT-01	LW35PTC-01	3.6
LW50	LW50PT-01	LW50PTC-01	4.2

*) For installation of a connector to a drive-in type grease fitting, contact NSK.

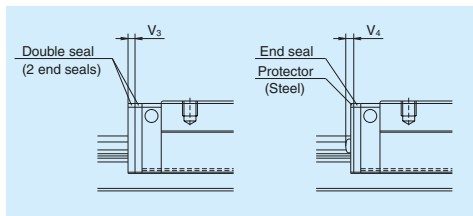

Fig. 12

(5) Cap to plug the rail mounting bolt hole

Table 15 Caps to plug rail bolt hole

Model No.	Bolt to secure rail	Cap reference No.	Quantity /case
LW17, LW21, LW27	M4	LG-CAP/M4	20
LW35	M6	LG-CAP/M6	20
LW50	M8	LG-CAP/M8	20

LW Series

(6) Bellows

- Make tap holes to the rail end face to fix the bellows mounting plate. NSK processes tap holes to the rail end face when ordered with a linear guide.

Dimension tables of bellows LW series

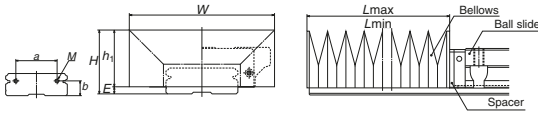

Fig. 13

Bellows reference number

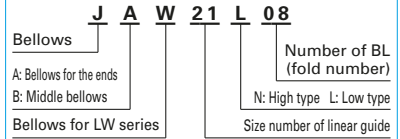

Table 16 Dimensions of bellows

Unit: mm

Model No.	H	h ₁	E	W	P	a	b	BL minimum length	Tap (M) x depth
JAW17N	25.5	23	2.5	68	15	22	6	17	M3 × 6
JAW21N	29	26	3	75	17	26	7	17	M3 × 6
JAW27N	37	33	4	85	20	28	10	17	M3 × 6
JAW35L	34	30	4	100	14	48	12	17	M4 × 8
JAW35N	41	37		115	20				
JAW50L	46.5	42	4.5	135	20	70	14	17	M4 × 8
JAW50N	56.5	52		160	30				

Table 17 Numbers of folds (BL) and length of bellows

Unit: mm

Model No.	Number of BL	2	4	6	8	10	12	14	16	18	20
		L _{min}	34	68	102	136	170	204	238	272	306
JAW17N	Stroke	176	352	528	704	880	1 056	1 232	1 408	1 584	1 760
	L _{max}	210	420	630	840	1 050	1 260	1 470	1 680	1 890	2 100
JAW21N	Stroke	204	408	612	816	1 020	1 224	1 428	1 632	1 836	2 040
	L _{max}	238	476	714	952	1 190	1 428	1 666	1 904	2 142	2 380
JAW27N	Stroke	246	492	738	984	1 230	1 476	1 722	1 968	2 214	2 460
	L _{max}	280	560	840	1 120	1 400	1 680	1 960	2 240	2 520	2 800
JAW35L	Stroke	162	324	486	648	810	972	1 134	1 296	1 458	1 620
	L _{max}	196	392	588	784	980	1 176	1 372	1 568	1 764	1 960
JAW35N	Stroke	218	436	654	872	1 090	1 308	1 526	1 744	1 962	2 180
	L _{max}	252	504	756	1 008	1 260	1 512	1 764	2 016	2 268	2 520
JAW50L	Stroke	246	492	738	984	1 230	1 476	1 722	1 968	2 214	2 460
	L _{max}	280	560	840	1 120	1 400	1 680	1 960	2 240	2 520	2 800
JAW50N	Stroke	386	772	1 158	1 544	1 930	2 316	2 702	3 088	3 474	3 860
	L _{max}	420	840	1 260	1 680	2 100	2 520	2 940	3 360	3 780	4 200

Note: The values of an odd number BL quantity (3, 5, 7, ...) can be obtained by adding two values of even number BL on the both sides, then by dividing the sum by 2.

LW Series

8. Reference number

Reference numbers shall be set to individual NSK linear guide when its specifications are finalized, and it is indicated on its specification drawing.

Please specify the reference number, except design serial number, to identify the product when ordering, requiring estimates, or inquiring about specifications from NSK.

(1) Reference number for preloaded assembly

LW 35 1000 EL C 2 -** P6 1	
Series name	Preload code (See page A173.) 0: Z0, 1: Z1, 3: Z3
Size	Accuracy code (See Table 19.)
Rail length (mm)	Design serial number
Ball slide shape code (See page A171.)	Added to the reference number.
Material/surface treatment code (See Table 18.) C: Special high carbon steel (NSK standard)	Number of ball slides per rail

(2) Reference number for random-matching type

LAW 35 EL Z -K	
Random-matching ball slide series code LAW: LW Series random-matching ball slide	Option code -K: Equipped with NSK K1 -F: Fluoride low temperature chrome plating + AS2 grease -F50: Fluoride low temperature chrome plating + LG2 grease
Size	Preload code No code: Fine clearance, Z: Slight preload
Ball slide shape code (See page A171.)	

L1W35 1000 L CN -** PC Z	
Random-matching rail series code L1W: LW Series random-matching rail	Preload code (See page A173.) T: Fine clearance. Z: Slight preload
Size	Accuracy code: PC PC: Normal grade is only available.
Rail length (mm)	Design serial number
Rail shape code: L L: Standard	Added to the reference number.
Material/surface treatment code (See Table 18.)	*Butting rail specification N: Non-butting. L: Butting specification

*Please consult with NSK for butting rail specification.

The reference number coding for the assembly of random-matching type is the same as that of preloaded assembly. However, only preload codes of "fine clearance T" and "slight preload Z" are available (refer to page A173).

Click!Speedy™ NSK Linear Guide Quick Delivery System uses a new numbering system. For details, please refer to the Click!Speedy general catalog CAT. No. E3191.

Table 18 Material/surface treatment code

Code	Description
C	Special high carbon steel (NSK standard)
D	Special high carbon steel with surface treatment
Z	Other, special

Table 19 Accuracy code

Accuracy	Standard (Without NSK K1)	With NSK K1	With NSK K1 for food and medical equipment
High precision grade	P5	K5	F5
Precision grade	P6	K6	F6
Normal grade	PN	KN	FN
Normal grade (random-matching type)	PC	KC	FC

Note: Refer to pages A38 and A61 for NSK K1 lubrication unit.

LW Series

(9) Dimensions

LW-EL

LW 35 1000 EL C 2 - PC Z**

Series name	LW	35	1000	EL	C	2	-**	PC	Z
Size									
Rail length (mm)									
Ball slide shape code (See page A171.)									
Material/surface treatment code (See Table 18.)									
C: Special high carbon steel (NSK standard)									
									Preload code (See page A173.) 0: Z0, 1: Z1, 3: Z3, T: ZT, Z: ZZ
									Accuracy code (See Table 19.)
									Design serial number
									Added to the reference number.
									Number of ball slides per rail

Front view

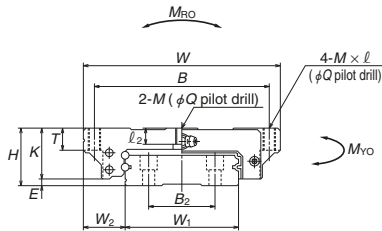

Side view

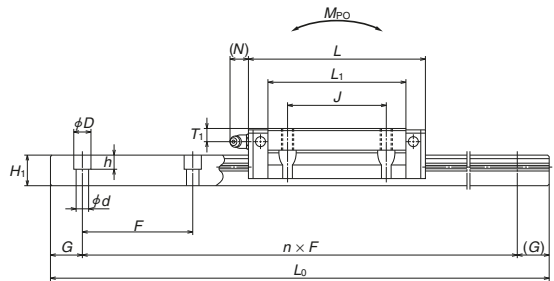

Model No.	Assembly			Ball slide											Width	Height		
	Height	E	W ₂	Width	Length	Mounting hole					L ₁	K	T	Grease fitting				
						B	J	M × pitch × l	l ₂	Q				Hole size			T ₁	N
LW17EL	17	2.5	13.5	60	51.4	53	26	M4×0.7×6	3.2	3.3	35	14.5	6	φ 3	4	3	33	8.7
LW21EL	21	3	15.5	68	58.8	60	29	M5×0.8×8	3.7	4.4	41	18	8	M6×0.75	4.5	11	37	10.5
LW27EL	27	4	19	80	74	70	40	M6×1×10	6	5.3	56	23	10	M6×0.75	6	11	42	15
LW35EL	35	4	25.5	120	108	107	60	M8×1.25×14	9	6.8	84	31	14	M6×0.75	8	11	69	19
LW50EL	50	4.5	36	162	140.6	144	80	M10×1.5×18	14	8.6	108	45.5	18	Rc1/8	14	14	90	24

Reference number for ball slide of random-matching type

LAW 35 EL Z -K

Random-matching ball slide series code
LAW: LW Series random-matching ball slide

Size

Ball slide shape code (See page A171.)

Option code

-K: Equipped with NSK K1
-F: Fluoride low temperature chrome plating + AS2 grease
-F50: Fluoride low temperature chrome plating + LG2 grease

Preload code

No code: Fine clearance, Z: Slight preload

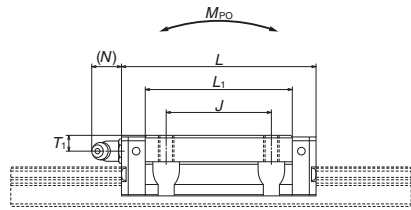
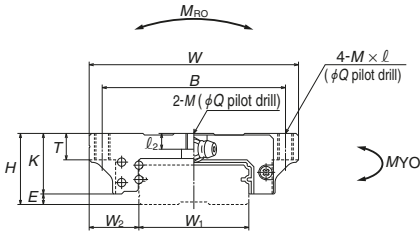

Reference number for rail of random-matching type

L1W35 1000 LCN - PC Z**

Random-matching rail series code

L1W: LW Series random-matching rail

Size

Rail length (mm)

Rail shape code: L

L: Standard

Material/surface treatment code (See Table 18.)

Preload code (See page A173.)

T: Fine clearance, Z: Slight preload

Accuracy code: PC

PC: Normal grade is only available.

Design serial number

Added to the reference number.

*Butting rail specification

N: Non-butting, L: Butting specification

*Please consult with NSK for butting rail specification.

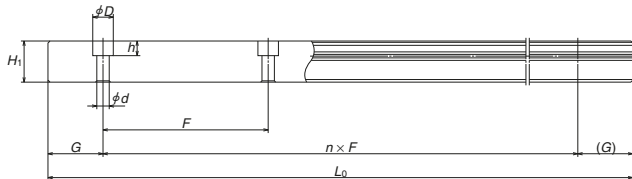
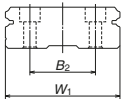

Unit: mm

Rail		Basic load rating							Weight					
Pitch	Mounting bolt hole	G	Max. length L_{max} () for stainless	Dynamic		Static C_0 (N)	M_{RO}	Static moment (N-m)		Ball slide (kg)	Rail (kg/m)			
				[50km] C_{50} (N)	[100km] C_{100} (N)			M_{PO}	M_{YO}					
				B_2	F	$d \times D \times h$	(reference)				One slide	Two slides	One slide	Two slides
18	40	4.5×7.5×5.3	15	1 000	5 600	4 450	11 300	135	44	288	37	242	0.2	2.1
22	50	4.5×7.5×5.3	15	1 600	6 450	5 150	13 900	185	65.5	400	55	335	0.3	2.9
24	60	4.5×7.5×5.3	20	2 000	12 800	10 200	26 900	400	171	970	143	815	0.5	4.7
40	80	7×11×9	20	2 000	33 000	26 400	66 500	1 690	645	3 550	545	2 990	1.5	9.6
60	80	9×14×12	20	2 000	61 500	48 500	117 000	3 900	1 530	8 200	1 280	6 900	4.0	15.8

Note: The basic load rating comply with the ISO standard. (ISO 14728-1, 14728-2)

C_{50} : the basic dynamic load rating for 50 km rated fatigue life C_{100} : the basic dynamic load rating for 100 km rated fatigue life